

Selective Laser Sintering of Duraform™ Polyamide with Small-Scale Features

Vinay Sriram, Kristin Wood, David Bourell and Joseph J Beaman

Department of Mechanical Engineering

Laboratory of Freeform Fabrication

The University of Texas at Austin, Austin, TX 78712

Reviewed, accepted August 25, 2003

Abstract

Selective Laser Sintering (SLS) has been used to make a fiber management module having very small feature size and ratios. Currently these modules are made out of Stereolithography using standard epoxy acrylate materials. SLS has been chosen to make these modules by the virtue of the material system it offers. The material system was chosen based on the flame retardant properties. The material used for this study is a Duraform™ Polyamide and Alumina-Ammonium Phosphate system. Ammonium Phosphate served as the binder in the Alumina-Ammonium Phosphate system. Experiments were done in order to find out the minimum feature size possible with the two material systems. Minimum hole diameters and maximum possible l/d ratios are determined by particle size, shape and processing conditions. Builds were made in different directions to understand the effect of the various processing parameters on the system. One particularly noteworthy observation was that part growth as a proportion of hole diameter became increasingly significant as hole size decreased. Optical microscopy was performed to measure the hole diameters and also to reveal the surface roughness. Results indicate material system determines the minimum diameter of micro-sized holes that can be effectively manufactured using Selective Laser Sintering.

Introduction

Selective Laser Sintering is a layer based manufacturing process. Successive layers of powder are deposited one above the other and the powder surface is raster scanned with a high power laser to achieve the desired geometry. The ability to manufacture any shape and geometry using Selective Laser Sintering has been well discussed in books and literature [1]. The current study focuses on manufacturing small sized features using three different material systems having flame retardant properties.

Initially Stereolithography was used to manufacture the desired geometry. Layers of photo-curable polymer are deposited from a vat and selective solidification is carried out by scanning with a laser beam. At a later stage the parts are flood exposed to UV light for 90 minutes to complete UV curing and is subjected to post thermal curing steps to achieve desirable properties of the material. The primary problem associated with Stereolithography

is using flame retardant polymers. In order to overcome this problem Selective Laser Sintering was selective as a viable technology based on the wide variety of material choices offered.

Objectives

1. The primary objective is to achieve hole diameter compatible with standard optical fibres.
2. Usage of flame retardant materials meeting UL 94 V0 standards.

The geometry of the Optical connector is as shown.

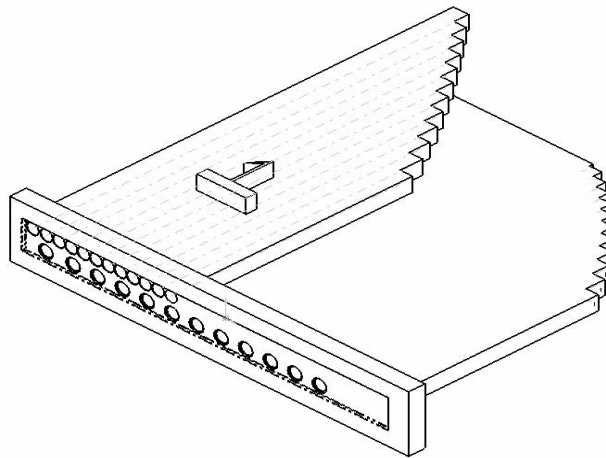

Material Requirements

The following are the material properties required in the manufacture of optical connectors.

Property	Requirement	Test Method
Glass Transition Temperature	120-130C	DMA
Moisture Absorption	< 1%	ASTM D570 95 % RH @ 600C for 14 days
Tensile Elongation at Break	3-4 %	ASTM D638
Tensile Modulus	350-450 Kpsi	ASTM D638
Tensile Strength	7-8 Kpsi	ASTM D638

Impact Resistance	0.4-0.6 ft-lb/in	ASTM D256
Heat Deflection Temperature	> 1200C at 256 psi	ASTM D648
Vibration Resistance	No cracks	10 to 55Hz per ETA/TIA FOTP

Table 1. Material Requirements

UL 94 VO flammability standards

This covers tests for flammability of plastic materials used for parts in devices and appliances. The standard consists of two tests which are Horizontal burning test (Ref 2) and the Vertical burning test. Table 2.0 shows the classification of materials as V0, V1 and V2 based on the afterflame and afterglow times.

Criteria Conditions	V-0	V-1	V-2
Afterflame time for each individual specimen	<= 10s	<= 30s	<= 30s
Total afterflame time for any condition set	<= 50s	<= 250s	<= 250s
Afterflame plus Afterglow time after second flame	<= 30s	<= 60s	<= 60s
Afterflame or afterglow up to holding clamp	No	No	No

Table 2. Flammability Criteria

Afterflame time is defined as the length of the time for which a material continues to flame under specified conditions, after the ignition source has been removed. Afterglow time has been defined as the length of time for which a material continues to glow under specified test conditions after the ignition source has been removed and or cessation of flaming.

Materials Chosen

Based on the above material properties needed the following 3 material systems were chosen

1. Duraform™ Polyamide
2. Alumina and Ammonium Phosphate
3. Alumina and Duraform™ Polyamide

Duraform™ Polyamide is a nylon based material and copyright of 3d Systems. It is one of the most widely used materials in Selective Laser Sintering Duraform™ and is used to build rugged durable thermoplastic parts and withstand aggressive functional testing. The table below gives a comparison of the properties of Duraform™ and the required properties.

Property	Requirement	Duraform™
Glass Transition Temperature	120-130C	185C
Moisture Absorption	< 1%	< 0.41%
Tensile Elongation at Break	3-4 %	9%
Tensile Modulus	350-450 Kpsi	220 Kpsi
Tensile Strength	7-8 Kpsi	6.2Kpsi
Impact Resistance Heat Deflection Temperature	0.4-0.6 ft-lb/in > 1200C at 256 psi	4 ft-lb/inch
Vibration Resistance	No cracks	168C at 66psi, 64C at 264psi
Flammability	UL 94 V0 standards	UL 94 V2 standards

Table 3. Duraform Properties

Duraform™ Polyamide satisfies all the requirements except for flammability. The tensile strength and tensile modulus as seen from the graph are slightly less than the required.

In the alumina-ammonium phosphate system, the ammonium-phosphate acts as the binder. This system is primarily chosen because of its ability to withstand high temperature, high density attainable, low shrinkage and good surface finish.

The optimum binder weight lies at 20% where shrinkage attained is minimal [3]. The melting point of Ammonium phosphate is around 190C and that of Alumina is around 2045C.

Based on the experiments done by Lakshminarayan and et al. the composition of the blend was 50 % by wt Alumina having a particle size of 70 μm , 25% by wt Alumina having a particle size of 10 μm and Ammonium phosphate having a particle size of 50 μm . The above blend provides the least shrinkage as compared to other particle sizes used.

The third material system used was alumina and Duraform system. Here the Duraform acts as the binder and Alumina as the base material. The optimum weight percentage of the binder is found to be between 20% and 30% by weight [1].

Initial Experiments

Experiments were done in order to find out the minimum hole diameter that is possible with the Duraform powder. A number of process parameters affect the Selective laser sintering process. The black box model of Otto and Wood [5.] is applied to the SLS process and all the parameters are classified as Performance variables, tuning variables, design variables and noise variables. The black box model is applied to the selective laser sintering process as shown in Fig 1.

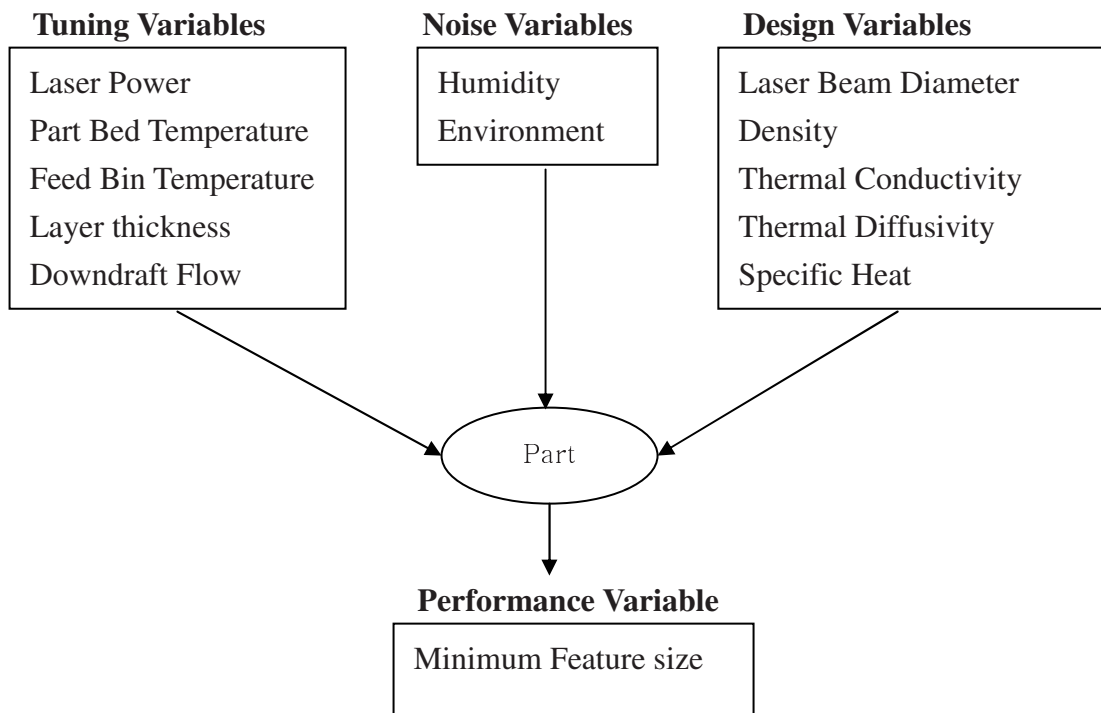

Fig1. Black Box Model of SLS

Based on all the above parameters standard values were chosen for a simple geometry to find out the minimum hole diameter possible. The process parameters are given below

Process Parameters	Value
Laser Power	5.5W
Fill Scan Speed	49.5 in/s
Bed Temperature	160 C
Layer Thickness	0.004 in
Outline Scan Speed	11.0 in/s

Table 4.

Results & Discussion

A simple geometry having holes of varying diameter and length is fabricated. The following graph shows the intended hole diameter and the actual measured diameter.

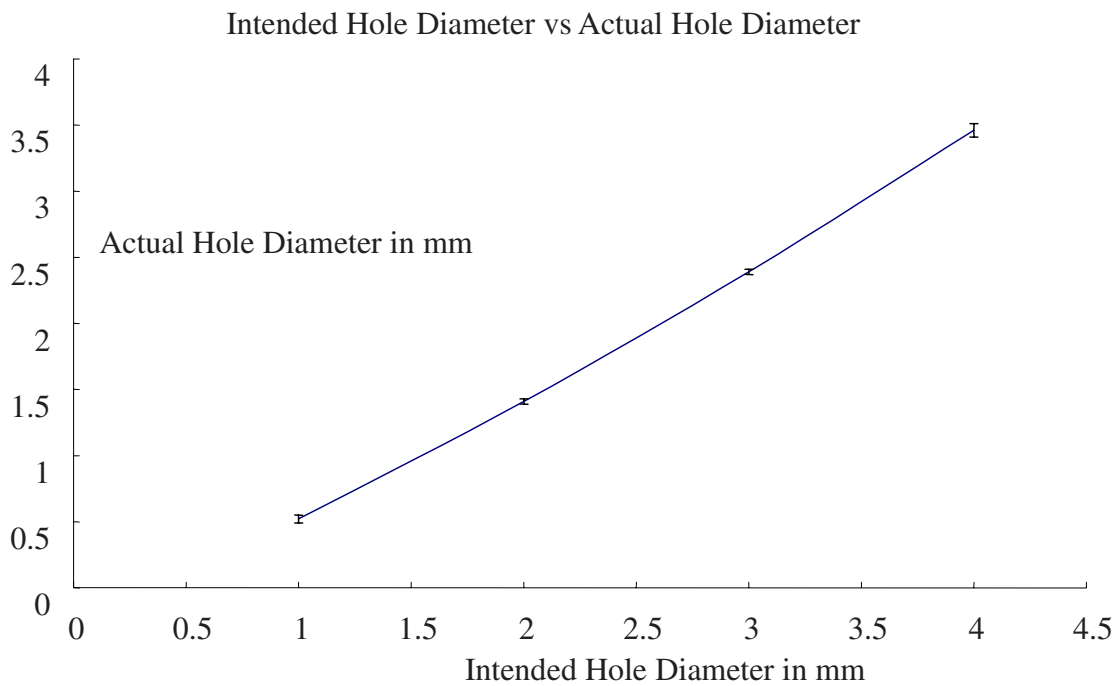

Fig 2. Graph of Intended Hole Diameter vs Actual Hole Diameter

The hole diameters were measured using Optical microscopy. From inspection of the graph, it is evident that shrinkage increases as the hole diameter decreases. The minimum hole diameter possible with the Duraform system was 0.52 ± 0.02 mm. The shrinkage for a intended hole diameter of 1.0mm was 48 %. Holes below 0.5mm are fully infiltrated with

powder. As a result it is not possible to measure the diameter. All the holes tested are straight and built in the vertical direction. Incorporating shrinkage pattern in the hole diameter it is possible to manufacture the required hole size.

The diameter of the hole with respect to l/d ratio is shown below. A set of 3 measurements were taken at the bottom, middle and top part of the cross-section of the pipe for all the material-systems and is shown in Figures 2, 4 and 7. The standard deviation indicates the overall variation of the diameter. It is seen that as l/d ratio increases there is lesser variation in the hole diameter. The significance of this is that it is possible to maintain concentricity of hole for long straight pipes. The minimum hole diameters possible is different for different material systems. The following photographs show hole diameter as measured by an optical microscope.

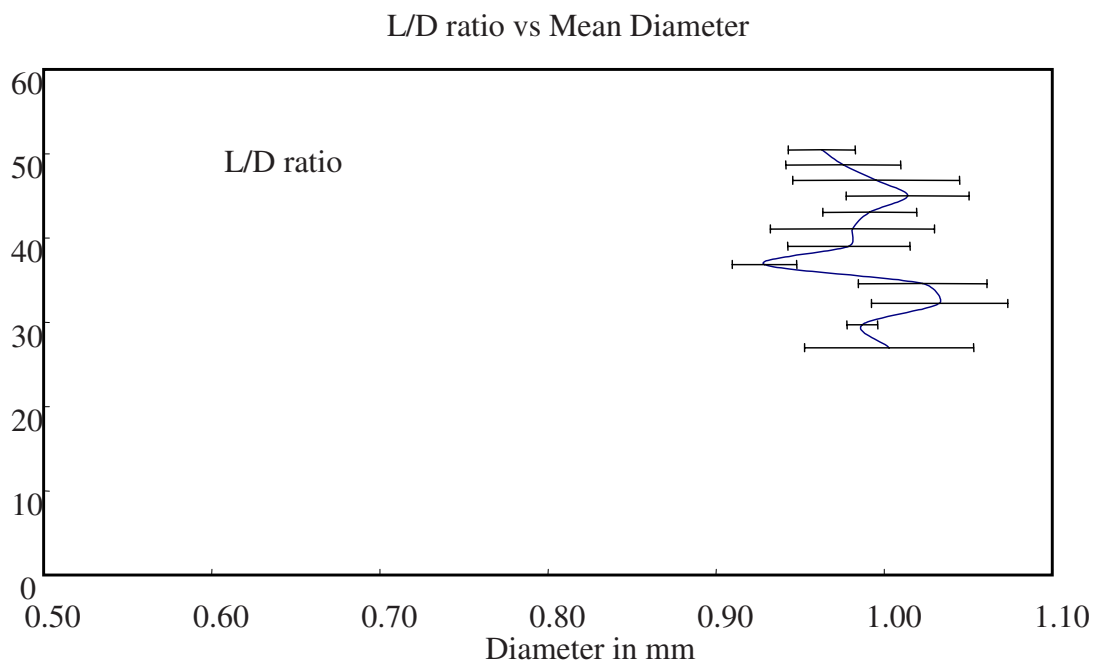

Fig 3. Feature size

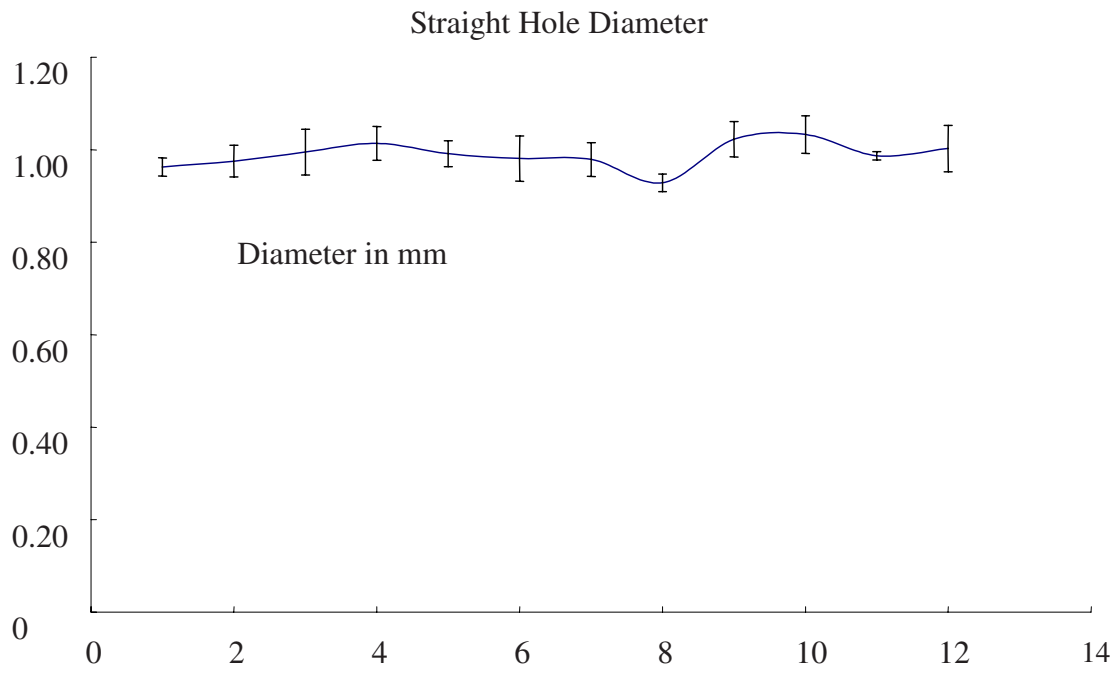

Fig 4. Hole Diameter with Error Bars

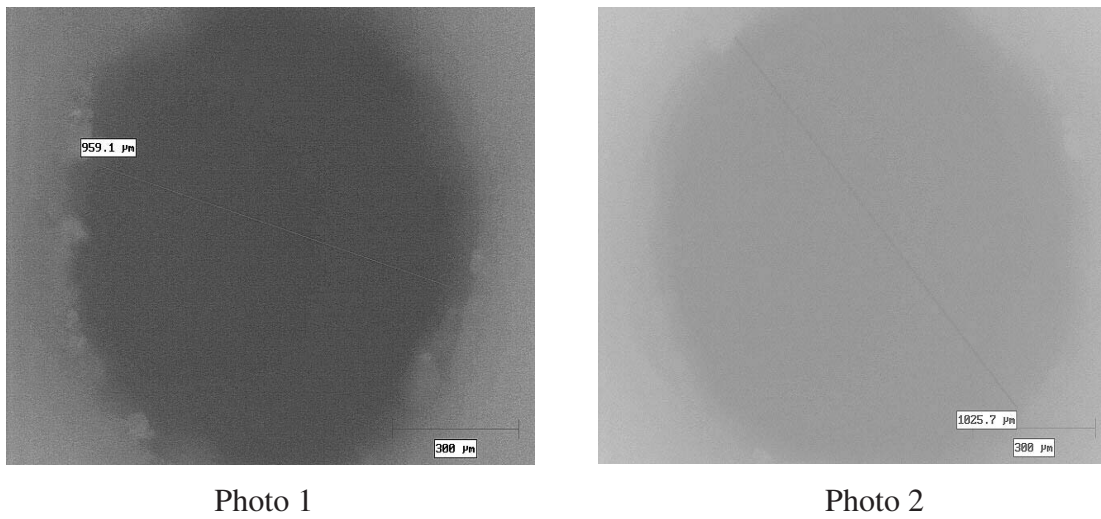

Fig 5. Photographs of Straight Pipes

Hole Diameter for curved pipes

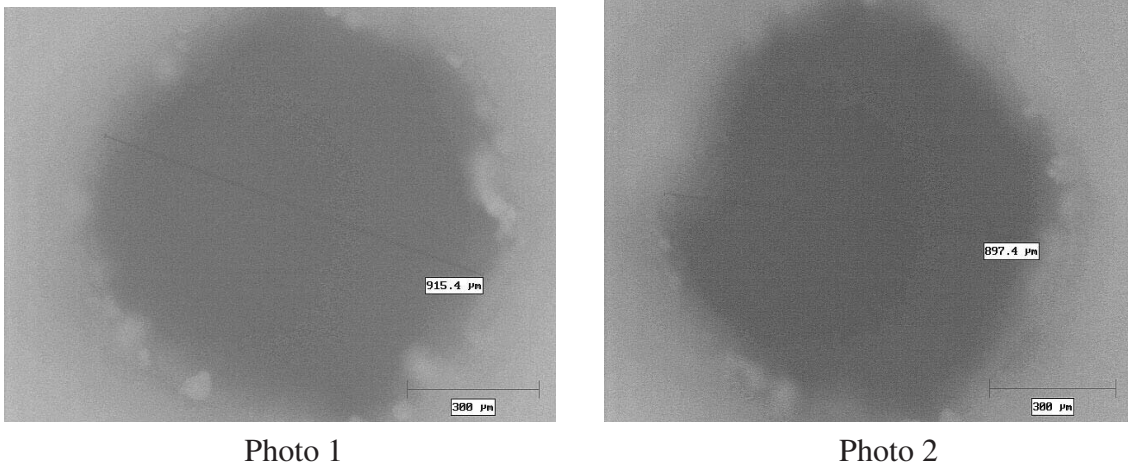

Fig 6. Photographs of Curved Pipes

The same amount of growth effect was incorporated for curved pipes. The results are shown below.

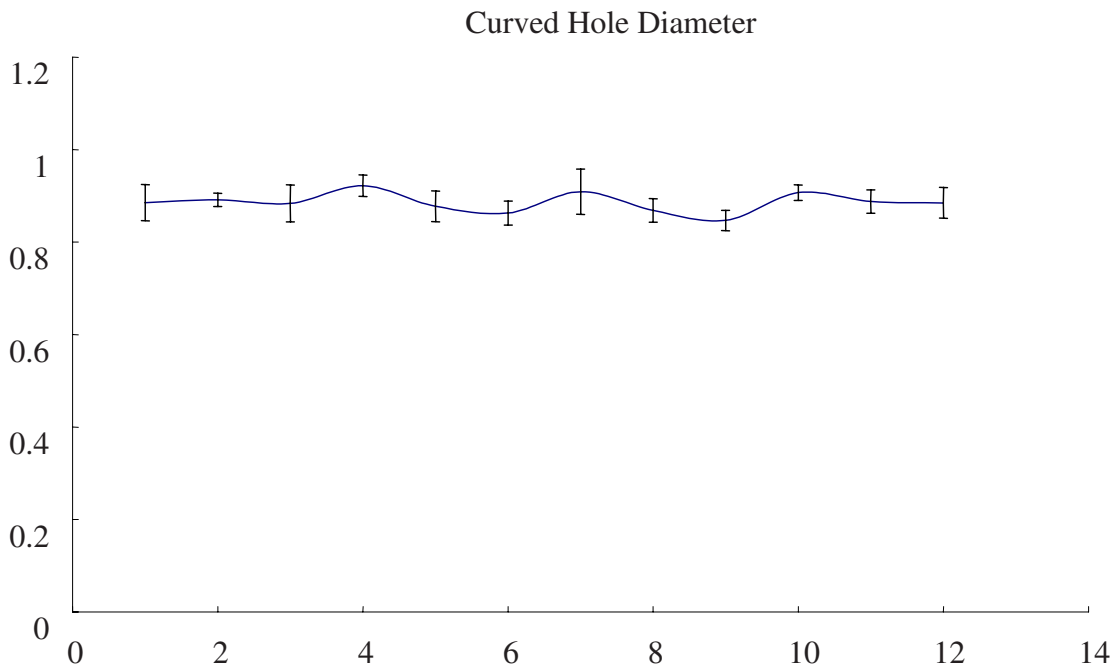

Fig 7. Curved Hole Diameter with Error bars

The most common problems encountered were growth effect, surface finish and powder removal. Growth occurs as powder sinters along the part, blurring features altering part dimensions and visibly apparent on small features such as holes. Growth effects can be taken into account by the above discussed method. Surface finish is affected by the particle

size of the powder, build direction and packing density of the powder. The best surface finish is achievable when virgin powder is used. Surface finish tends to degrade on repeated use of the old powder. Streak lines are noticeable on the part when it is built in the horizontal direction. Streaking primarily occurs because the Duraform powder is too hot and tends to stick to the roller. One approach to avoid streaking is to reduce the feed bin temperature by 3 or 4 degree centigrade. Powder can be removed either by vacuuming or blowing it using a sand blaster. For holes smaller than 1mm diameter the friction coefficient is rather high between the loose powder particles and the inner surface of the hole. This creates difficulty in removing the powder. The powder is basically removed by using steel wires of varying diameters. Smaller wire diameters loosen the powder and the bigger wires are used to remove the powder. The hole diameter is then verified by passing an optical fibre through the connector.

The second material system tried was Alumina-Ammonium phosphate system. In this system the binder is Ammonium phosphate. The parameters chosen are as follows.

Parameter	Value
Laser Power	20 W
Scan Speed	4 cm/s
Bed Temperature	21 0C
Layer Thickness	0.2mm
Scan Distance	0.5mm

Table 5. Parameters for Alumina-Ammonium Phosphate System

The major problems associated were crumbling of the part, achieving right particle size and blending of powder. The weak porosity of the part resulted in crumbling of the optical connector as a result no dimensions of the parts could be obtained. The reason behind the weak porosity is incorrect binder particle size. The binder particles were slightly greater than those that were given in the literature and resulted in incomplete bonding of the alumina to Ammonium phosphate.

The third material system that is tried out is the Duraform – Alumina system. Here Duraform acts as the binder for the alumina particles. A mixture consisting of 78 % by weight of Alumina and 22 % by weight of Duraform is prepared. The processing parameters are the same as that of Duraform alone apart from lowering the feed bin temperature to prevent glazing effect. One of the primary concerns in this material system is also powder removal. The diameter measured for this material system is 1.02 ± 0.02 mm.

Conclusion

It is possible to achieve small scale features using Duraform to manufacture optical connectors. The shrinkage measurements were done only for straight pipes. Curved pipes exhibit considerably more growth and further study needs to be done to understand them. Incorporating growth effect of straight pipes to that of the curved pipes works only to certain extent. Understanding the phenomenon of growth for different material systems it is possible to make virtually any complicated hole structure without sacrificing accuracy and hole tolerances.

References

1. Beaman, Joseph, et al. Solid FreeForm Fabrication. Austin: Kluwer, 1997.
2. Lakshminarayan, Uday. Selective Laser Sintering of Ceramic Materials. Diss. Univ of Texas at Austin, 1993, Austin.
3. Wood, Kirstin and Otto Kevin. Product Design. New Jersey: Prentice Hall, 2001.
4. Lee, William, et al. Ceramic Microstructures. Sheffield: Chapman, 1994.
5. Epel, Joseph, et al. Engineering Plastics. Vol. 2 Cleveland: ASTM, 1988.